

8	7	6	5	4	3	2	1
AVAILABLE ACCESSORIES - DOUBLE SIDED TAPES - EPOXY ATTACHMENT - THERMAL GREASE - THERMAL INTERFACE MATERIALS - ATTACHMENT CLIP & ANCHORS	FINISHES - BLACK ANODIZE (OTHER COLORS ON REQUEST) - CHROMATE (CLEAR & GOLD) - CLEAN OR MILL FINISH - PAINTING AND POWDERCOAT	OPTIONS - CROSS CUT - CUSTOM MACHINING - PART MARKING - BAR CODING	SIMULATION AND ANALYSIS - THERMAL ANALYSIS - CFD MODELING FOR SYSTEM AND COMPONENT LEVELS - PARAMETRIC MODELING	MANUFACTURING - CNC MACHINING - SHEET METAL - PROTOTYPE & PRODUCTION - CUSTOM EXTRUSION PROFILES AND STAMPINGS	WEB SITE LINKS HTTP://www.heatsinks.com HTTP://www.allaxismachining.com	THERMAL PERFORMANCE	

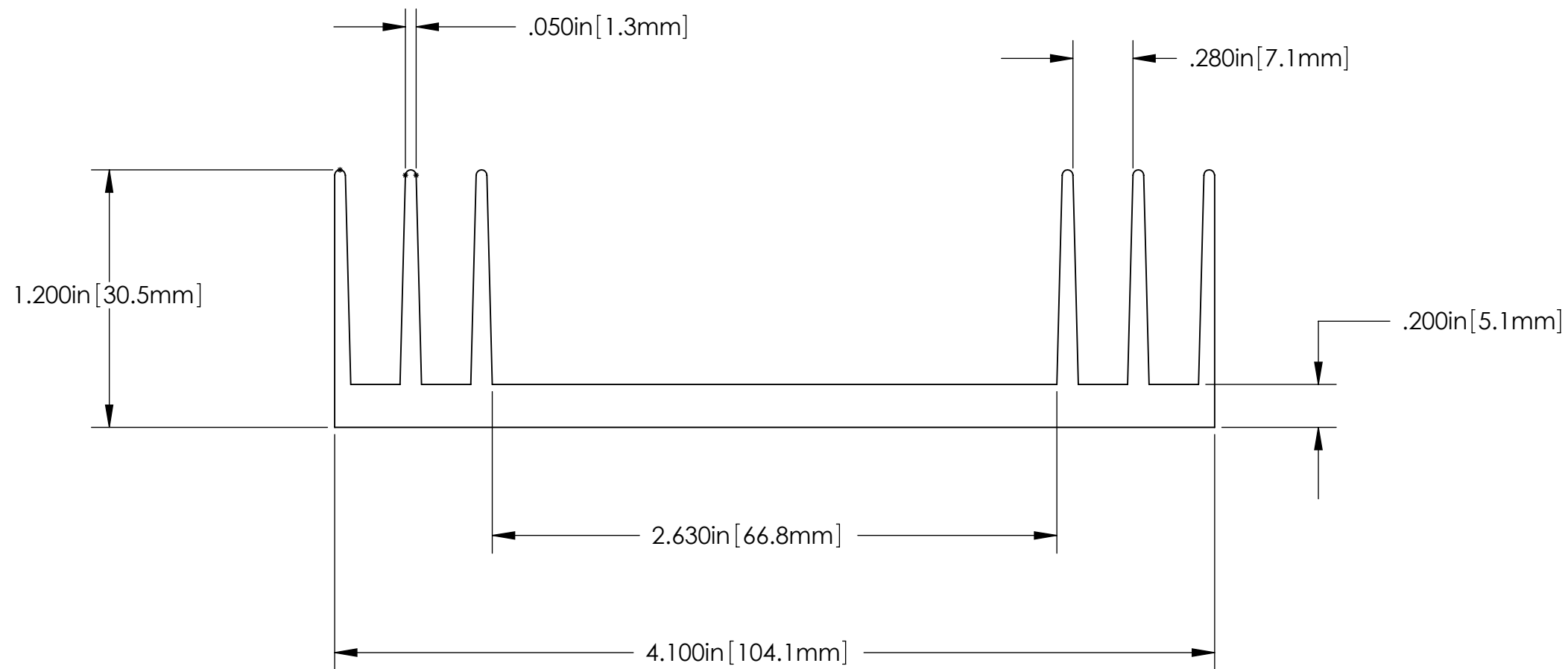

Notes:
 1. Finish - None
 2. Material: Extrusions: 6063 Aluminum;
 3. Physical Properties: Mass = 1.45 lbs/ft; 2.16 Kg/m
 Perimeter = 20.22 inches; 51.36 cm
 4. All Dimensions Shown on Print are for Reference Only, Contact Factory for any Critical to Function Tolerances such as flatness, height, width, diameter, distance, etc.

ROHS Compliant Certification - EU Directive 2002/95/EC

Material Name	Maximum Concentration by Weight
Cadmium and its Compounds	< 0.01%
Mercury and its Compounds	< 0.01%
Lead and its Compounds	< 0.01%
Hexavalent Chromium CR+6 and its compounds	< 0.01%
Polybrominated Bi-phenyls (PBB)	< 0.01%
Polybrominated Diphenyl Ethers/Oxides (PBDE & PBDO)	< 0.01%
Polychlorinated Biphenyls	0%
Polychlorinated Terphenyls	0%
Abestos (All Forms)	0%



Uncontrolled Drawing

PROPRIETARY AND CONFIDENTIAL

THE INFORMATION CONTAINED IN THIS DRAWING IS COPYRIGHTED 2007 AND IS THE SOLE PROPERTY OF ALL AXIS MACHINING ANY REPRODUCTION IN PART OR AS A WHOLE WITHOUT THE WRITTEN PERMISSION OF ALL AXIS MACHINING IS PROHIBITED.

DIMENSIONS AND TOLERANCES
 EXTRUDED FEATURES PER ALUMINUM
 INDUSTRY STANDARDS

COMMENTS:

CAD FILES AND DYNAMIC THERMAL MODELS ARE AVAILABLE FOR DOWNLOAD FROM WEBSITE

www.heatsinks.com
 Email: gkuzmin@heatsinks.com
 Phone: 972 312 8609 Fax: 972 312 8617



Part Number:

E2346