

8	7	6	5	4	3	2	1
AVAILABLE ACCESSORIES - DOUBLE SIDED TAPES - EPOXY ATTACHMENT - THERMAL GREASE - THERMAL INTERFACE MATERIALS - ATTACHMENT CLIP & ANCHORS	FINISHES - BLACK ANODIZE (OTHER COLORS ON REQUEST) - CHROMATE (CLEAR & GOLD) - CLEAN OR MILL FINISH - PAINTING AND POWDERCOAT	OPTIONS - CROSS CUT - CUSTOM MACHINING - PART MARKING - BAR CODING	SIMULATION AND ANALYSIS - THERMAL ANALYSIS - CFD MODELING FOR SYSTEM AND COMPONENT LEVELS - PARAMETRIC MODELING	MANUFACTURING - CNC MACHINING - SHEET METAL - PROTOTYPE & PRODUCTION - CUSTOM EXTRUSION PROFILES AND STAMPINGS	WEB SITE LINKS HTTP://www.heatsinks.com HTTP://www.allaxismachining.com	THERMAL PERFORMANCE	

D

D

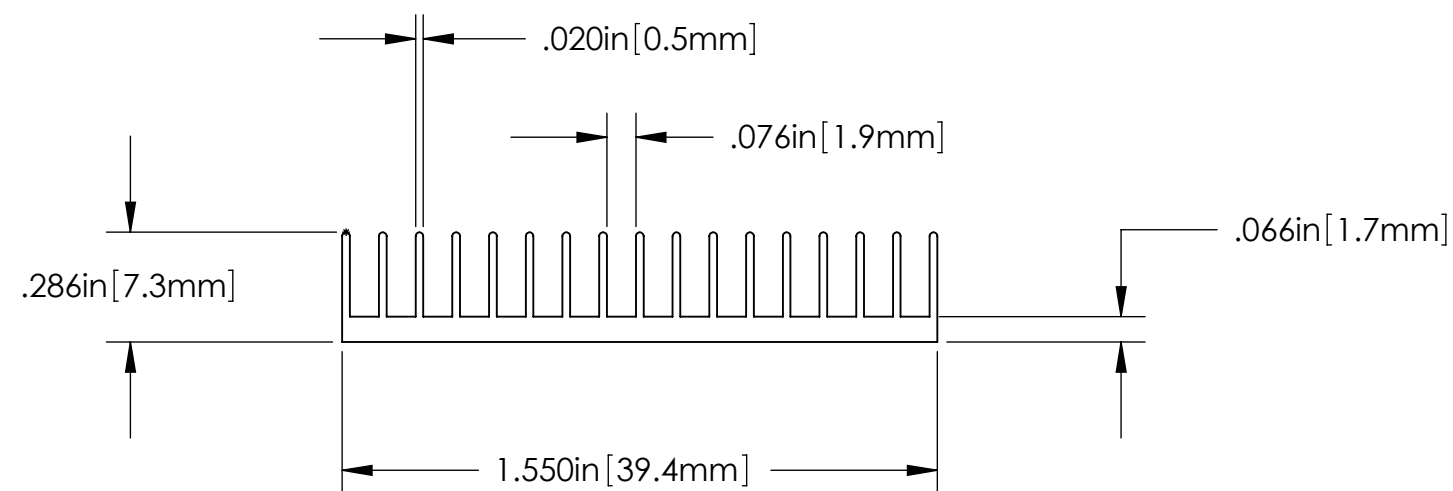

C

B

B

A

A

Notes:

1. Finish - None
2. Material: Extrusions: 6063 Aluminum;
3. Physical Properties: Mass = 0.21 lbs/ft; 0.31 Kg/m
Perimeter = 10.57 inches; 26.84 cm
4. All Dimensions Shown on Print are for Reference Only, Contact Factory for any Critical to Function Tolerances such as flatness, height, width, diameter, distance, etc.

ROHS Compliant Certification - EU Directive 2002/95/EC

Material Name	Maximum Concentration by Weight
Cadmium and its Compounds	< 0.01%
Mercury and its Compounds	< 0.01%
Lead and its Compounds	< 0.01%
Hexavalent Chromium CR+6 and its compounds	< 0.01%
Polybrominated Bi-phenyls (PBB)	< 0.01%
Polybrominated Diphenyl Ethers/Oxides (PBDE & PBDO)	< 0.01%
Polychlorinated Biphenyls	0%
Polychlorinated Terphenyls	0%
Abestos (All Forms)	0%



RoHS compliant

Uncontrolled Drawing

PROPRIETARY AND CONFIDENTIAL

THE INFORMATION CONTAINED IN THIS DRAWING IS COPYRIGHTED 2007 AND IS THE SOLE PROPERTY OF ALL AXIS MACHINING ANY REPRODUCTION IN PART OR AS A WHOLE WITHOUT THE WRITTEN PERMISSION OF ALL AXIS MACHINING IS PROHIBITED.

DIMENSIONS AND TOLERANCES
EXTRUDED FEATURES PER ALUMINUM
INDUSTRY STANDARDS

COMMENTS:

CAD FILES AND DYNAMIC THERMAL MODELS ARE AVAILABLE FOR DOWNLOAD FROM WEBSITE

www.heatsinks.com
Email: gkuzmin@heatsinks.com
Phone: 972 312 8609 Fax: 972 312 8617

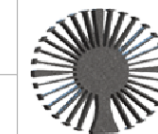

Heatsinks.com

The Thermal Management Division of All Axis Machining

Part Number:

E2239

8

7

6

5

4

3

2

1